

SB Series

Weighing Platform

The SB series is a water & dust proof platform protected to IP-65 standards.
Models: SB-15K10-D, SB-60K11-D,
SB-100K12-D, SB-200K12-D



AND

A&D Mercury Pty. Ltd.

www.andmercury.com.au

...Clearly a Better Value

SB Series Weighing Platform

Specifications

Model	SB-15K10-D	SB-60K11-D	SB-100K12-D	SB-200K12-D
Capacity	15kg	60kg	100kg	220kg
Zero balance	0.20mV/V \pm 0.1mV/V	0.16mV/V \pm 0.1mV/V	0.16mV/V \pm 0.1mV/V	0.13mV/V \pm 0.1mV/V
Rated output	1mV/V \pm 10%			
Linearity & Hysteresis	0.03% of R.O.			
Compensated temperature range	-10°C to +40°C			
Maximum excitation voltage	15V DC			
Input terminal resistance	1190 Ω \pm 50 Ω			
Output terminal resistance	1000 Ω \pm 10 Ω			
Isolation resistance	Greater than 5000M Ω at 50V DC			
Cable	Ø4mm \times 3m, shielded cable with 4 conductors			
Weighing pan size (W \times D mm)	250 \times 250	330 \times 424	390 \times 530	
Platform weight (Approximately)	4.5 kg	8.0 kg	14.0 kg	
Weighing pan material	Stainless steel			
Base unit material	Plastic/Stainless steel	Aluminium Alloy Die-castings		

Physical Dimensions (Unit: mm)

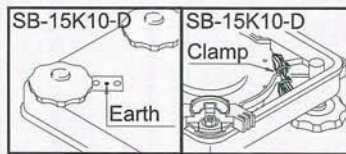
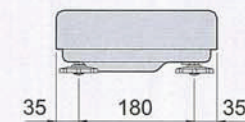
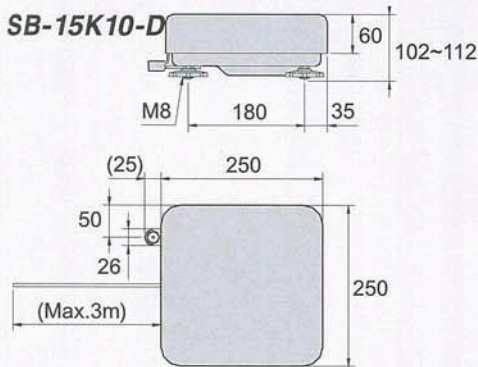

Cable color and its connection

Cable color	Connection
Red	Excitation + (Input terminal)
White	Excitation - (Input terminal)
Green	Signal + (Output terminal)
Blue	Signal - (Output terminal)
Yellow	Shield

SB-60K11-D, SB-100K12-D, SB-200K12-D

Unit: mm

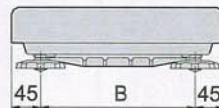
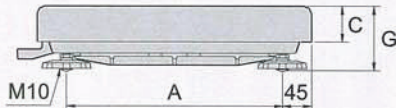

	SB-60K11-D	SB-100K12-D	SB-200K12-D
A	334	440	
B	240	300	
C	55	70	
D	330	390	
E	424	530	
F	85	115	
G	105 to 115	129 to 139	
L	Maximum 3m		

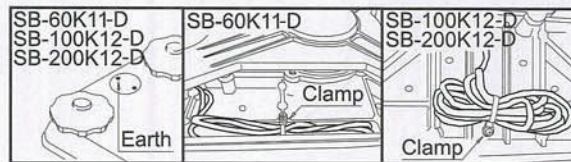
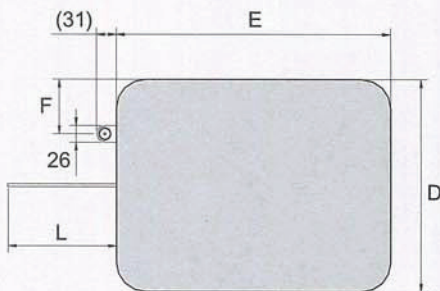

Specifications subject to change for improvement without notice.

AND

A&D MERCURY PTY. LTD.
ACN 007 556 809
Head Office
32 Dew Street
THEBARTON
SA 5031
Telephone (08) 8301 8100
Facsimile (08) 8352 7409

Victorian Office
Unit 4, 313 Arden Street
KENSINGTON
Victoria 3031
Telephone (03) 9372 1522
Facsimile (03) 9372 1193

New South Wales Office
Unit 4, 14 Abbott Road
SEVEN HILLS
New South Wales 2147
Telephone (02) 9674 5466
Facsimile (02) 9674 2544

Email: sales@andmercury.com.au
Internet page: <http://www.andmercury.com.au>

Your Dealer