

Large Displays

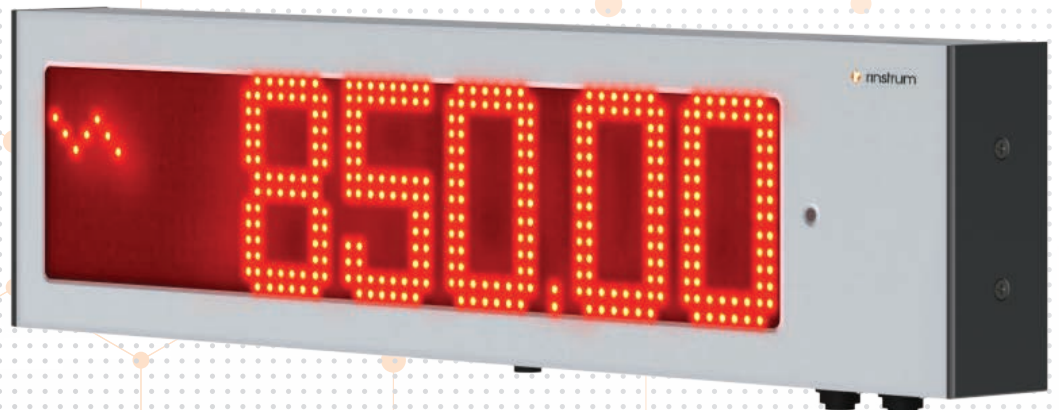

rinstrum
SMART WEIGHING SOLUTIONS



D800 and D700 Series Remote Displays

Rinstrum remote displays are designed for harsh industrial and agricultural applications typical of the weighing industry. Feedback from service technicians and scale installers helped guide the design process which resulted in reliable and service friendly remote displays. Simple mounting brackets, extruded aluminum housings, innovative wiring connections and optical isolation (on the communications port) give Rinstrum remote displays excellent price/performance value.

D732 Numeric super bright LED remote display

D732 offers numeric only digits, auto dimming for low light conditions and built-in traffic lights. The D732 is compatible with 5 communication protocols including Rinstrum A, C, D and Condec.

- Super Bright LEDs
- Wide viewing angle
- Suitable for external use
- Isolated RS232/485 serial
- Traffic lights (via control character in supported protocols)
- Auto detecting setup With Rinstrum indicators



D800 Series Alpha super bright LED remote display

The D800 Series remote displays offer alphanumeric characters and built in annunciators plus the convenience of Auto-baud and Auto-protocol communications. The D800 series is compatible with over 25 communication protocols.

D841 includes integral Red/Green traffic lights with software or hardware control. All versions include auto dimming for low light conditions. The traffic lights can be controlled by a hardware switch or a control character in the supported protocols.

D840 and D850 will display "STOP" for Red, "GO" for Green and "-----" for traffic light inputs.

- Super Bright LEDs
- VAC, VDC Power options
- Isolated RS232/485 serial or Ethernet
- Alpha numeric characters for improved readability
- Auto detecting setup with Rinstrum Indicators
- Compatibility with large range of indicator manufacturers
- Unit and Annunciators display
- Wide viewing angle



Rinstrum Remote Display PC Configurator

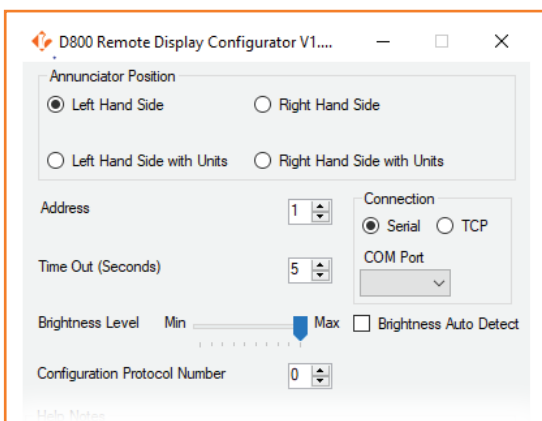

- DA004 Display config cable connects the remote to PC via USB
- Ethernet available remotes connect to PC via LAN network
- Brightness level control
- Annunciator position update
- Address selection

The benefits of our LED Remote displays

3 Configuration

- Auto-select protocol
- Auto-baud configuration
- Auto-brightness control

1 Service

- Waterproof field wireable connectors
- Simple mounting brackets and weather hood
- Universal VESA mounting hole pattern
- Light weight, easily installed by one man

4 Display

- Super bright OSRAM LEDs give excellent readability
- 120 degree viewing angle from all directions

2 Design

- Sealed aluminum housing, IP65
- Robust 110-240 VAC power supply
- Independently tested against interference from RFI and EMI

Specification Table

	D732	D840	D841	D850
Display	Super Bright LEDs			
	28 LEDs per digit 7 Segment, Numeric characters, Single row of LEDs	Alpha numeric characters, Double row of LEDs		
Digits	Six (6) digit	Six (6) digits + Annunciators or Seven (7) digits		
Digit Height	75mm (3in)	100mm (4in)		140mm (5.5in)
Approximate Visibility	20m (66feet)	30m (100feet)		70m (230feet)
Traffic Light	Dedicated Red/Green	-	Dedicated Red/Green	-
Annunciators	-	Motion, Centre of Zero, Net		
Display Units (Protocol Dependent)	Adhesive sticker	Display Units (either right or left hand side) Adhesive sticker		
AC Power	110-240VAC 50/60Hz 32W MAX	110-240VAC 50/60Hz 32W MAX		
DC Power (Factory fit)	-	24VDC (18-36VDC) or 12VDC 9 (9-18VDC) 30 W MAX		
Environment Rating	IP65			
Mounting Option	Weather Hood D73x Weather Hood (DA001)	D84x Weather Hood (DA002)		-
	Mounting Plate	VESA and RAM compatible mounting points (DA003)		
Weight	3.3kg (7.3lb)	4.2kg (9.3lb)	4.6kg (10.2lb)	7.4 kg (16.3lb)
Ethernet Interface	No	Factory fit		Factory fit

D732

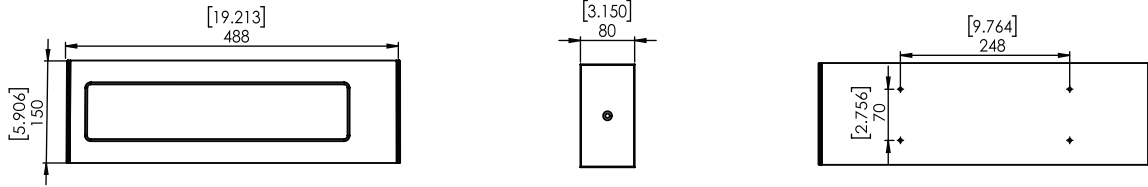

D840

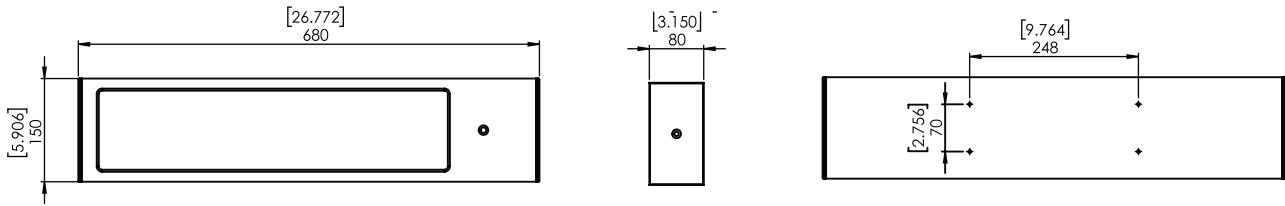

D841

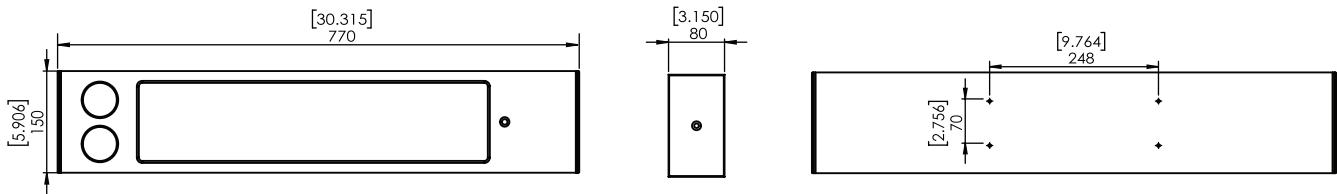

D850

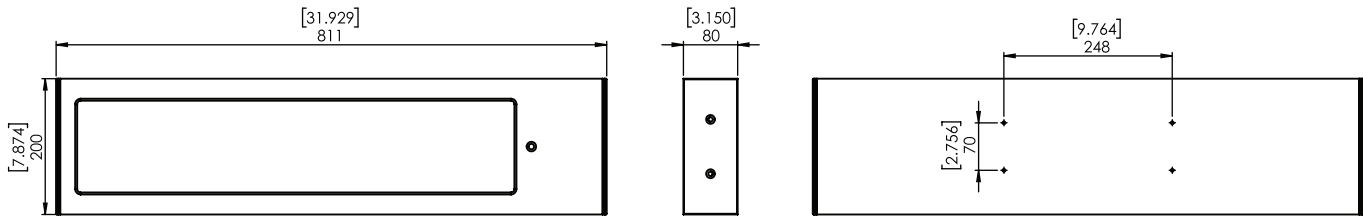

D732 Weather Hood

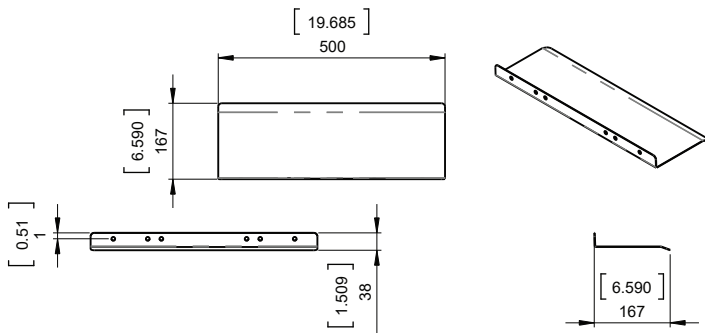

D840/D841 Weather Hood

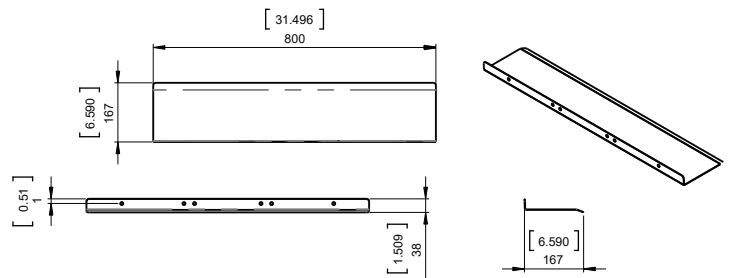

AUSTRALIA

Rinstrum Pty Ltd
 Unit 4/31 Henry Street
 Loganholme
 QLD 4129
 Australia

Ph: +61 7 3216 7166
 Email: sales.au@rinstrum.com

USA

Rinstrum Inc
 1349 Piedmont Drive
 Troy, Michigan 48083
 United States

Toll Free 1 877 829 9152
 Ph: +1 248 680 0320
 Fax: +1 248 499 1331
 Email: sales.us@rinstrum.com

EUROPE

Rinstrum Europe GmbH
 Hans-Böckler-Straße 42
 D-40764 Langenfeld
 Germany

Ph: +49 (0)2173 16562-10
 Fax: +49 (0)2173 16562-29
 Email: sales.eu@rinstrum.com